

1. Introduce

RF-TTL-100 is our latest 100mW wireless transmission module. It working in 148-173.5MHz band and using serial port to send or receive data. Its advantage is that centralized power density, transmission distance(*Its transmission distances can reach 2000 meters.*) and strong anti-jamming capability. Especially the ability to penetrate diffraction, it is more strong than other band.

RF-TTL-100 having the FEC forward error correction algorithm, the coding efficiency is higher and the error correction capability is strong. When in the case of burst interference, it can take the initiative to correct the interference packets , that greatly improving the reliability and transmission distance. The module also having data encryption and compression function. When transmission data in the air, it is random and unsafe. But after the module rigorous encryption and decryption algorithm, the data interception becomes meaningless and improves transport security.

The module has four operating modes , and can freely switch at runtime , in the power saving mode , current consumption is only ten of uA, it is very suitable for ultra-low- power applications.

2. Parametric Description

Num	Parametric Name	Detailed Description
1	Module size	20* 36mm
2	Interface	1*7*2.54mm, you can use the universal plate and DuPont line
3	Supply voltage	2.0-3.6V DC
4	Communication voltage	0.7VDD-5.2VDC, VDD is the supply voltage of module
5	Measured distance	1800m@1K
6	Maximum power	20dbm
7	Air Rate	8 adjustable rating
8	Dormancy Current	About 1.7uA (M1 =1, M0 = 1)
9	Power Level	8 adjustable rating
10	Transmitting current	89mA@100mW output
11	Receiving current	14.5mA@Mode 0 and 1. The lowest is about 20uA@Mode 2 + 2s wake up
12	Antenna	SMA external antenna(You can support our 170M dedicated antenna)
13	Communication Interface	UART serial port, 8N1/8E1/8O1, from 1200 to 115200 a total of 8 kinds baud rate
14	Transmitting length	Single data packet is 256 bytes
15	Receiving length	Single data packet is 256 bytes
16	RSSI Support	Built-in intelligent processing
17	Reception sensitivity	-119dbm@1Kbps
18	Work temperature	-30 - +85°C
19	Work humidity	Relative humidity :10% - 90%
20	Storage temperature	-40 - +125°C
21	Working frequency	148MHz – 173.2MHZ, 100KHz stepper



M/N: RF-TTL-100
Figure 1

3. Module Features

- Transmission distance of 2000 meters
- 8 kind baud
- -119dBm Receiver sensitivity
- Ultra-low -power receive
- Four operation modes
- Sleep current is only 1.7uA
- Air wake-up function
- Double ring buffer 256Bytes
- Built-in watchdog , never crash
- Software FEC correction , data compression
- Support voltage reading function
- Frequency 148-173.5M, 256 channels
- Efficient encryption algorithms , error correction function

4. Application

- Wireless meter reading
- Wireless Sensor
- Smart Home
- Intelligent Robot
- Consumer Electronics
- Street lighting control
- High-voltage monitoring
- Environmental Engineering
- Automated data collection
- Remote control and monitoring
- Other wireless transmission applications

5. Module pins and dimensions

Pin Num	Pin Name	Pin Direction	Application
1	M0	Input(Very weak pullup)	Match with M1, select 4 operating modes of the module. Do not leave
2	M1	Input(Very weak pullup)	Match with M0, select 4 operating modes of the module. Do not leave
3	RXD	Input	TTL serial input and it connected to an external TXD out pin
4	TXD	Output	TTL serial output and it connected to an external RXD out pin
5	AUX	Output	Used to indicate the status of the module
6	VDD		Power provide, must be between 2.0 to 3.6 DC(Unit: V)
7	GND		Ground

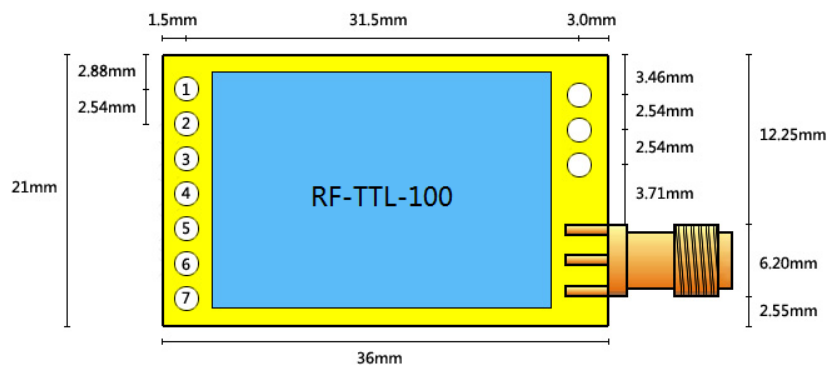

Figure 2

6. Power Requirements

The supply voltage of RF-TTL-100 is 1.9V-3.6V DC, and the current supply capability of the power supply is not less than 200MA. When the module transmitting data, due to the current mutation lead to a greater supply ripple. So users must have an external circuit ripple rejection.

You must pay more attention on using low quiescent current and low dropout LDO, because common LDO ripple rejection is poor. When you use the ordinary linear regulator, or a larger quiescent current regulator, or DCDC DC converter , the situation will be much more optimistic .

The power supply is a prerequisite for good quality wireless module stability and effectively enhance the transmission distance, receiver sensitivity , and life.

7. Module Reset

After the module is powered, AUX will immediately output low, begin the hardware self-test and work in accordance with the user parameter settings. In this process, the AUX keep low. After, AUX out high and work in accordance with predetermined operating mode. So users need to wait AUX rising edge, working as a starting point of the module.

8. AUX Detail introduction

AUX is used for wireless transmission indication and output indicator. It indicates whether the data has not been emitted by wireless from the module, or the wireless data has been received.

In the following case, if they meet any one condition, the AUX will output low:

1. User via a serial port to send data to the module , and it has not completely written to the wireless chip.
2. Wireless module received data, and it has not completely send to user.
3. In the process of resetting the module has not yet completed the self-test , or has not been initialized.

When the following conditions are met, the AUX output low:

All user data have been written to the wireless chip and have started launching. At the same time, the module dose not receive wireless data, and need not output serial data to the user.

- Function 1: Serial transmit instruction(Can be used to wake up the dormant external MCU)

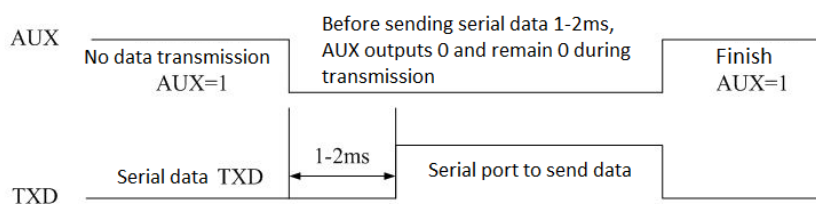

Figure 3

- Function 2: Wireless transmit instruction

Buffer empty: 256 bytes of the internal data buffer are being written to the wireless chip.

Buffer is not empty: 256 bytes of internal data buffer , not yet fully written to the wireless chip and turn launch , the module is possible at the end of the timeout waiting for the user data , or ongoing subcontracting wireless transmitter

NOTICE: When AUX is high, it does not mean that all serial data are transmitted over is completed, it may end up in a pack of data being transmitted .

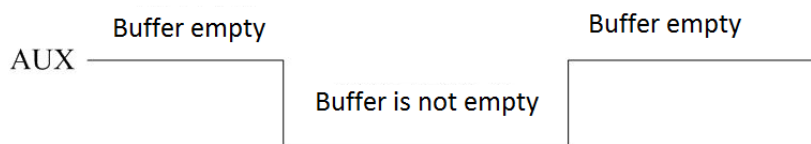

Figure 4

- Function 3: The module is the configuration process(Only in the reset and exit sleep mode)

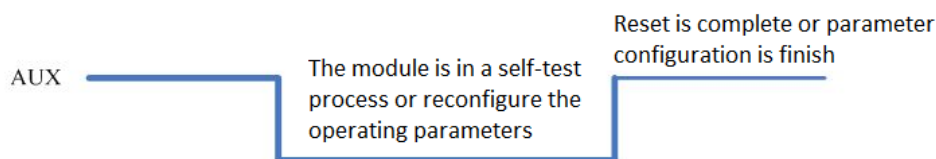

Figure 5

Attention:

1. 1 and 2 above functions, output low priority , it is namely : to meet any one of the output low condition , AUX outputs low. When all the low-level conditions are not satisfied , AUX output high.
2. When the AUX output low , indicating that the module is busy at this time does not work mode detection .
3. When the user to switch to a new operation mode, at least 2ms after the rising edge of the AUX, the module will truly enter this mode.
4. Users enter from SLEEP mode to the normal operating mode , or in the reset process , the module will re-set user parameters. And in the configuration process , the AUX will output low.

9. Working Mode

Working mode	M1	M0	Introduction	Remark
0 General mode	0	0	Serial open and wireless open , transparent transmission	The receiver must be modes 0,1
1 Weak-up mode	0	1	Serial open and wireless open	The receiver can be mode 0,1,2
2 Power-saving mode	1	0	Serial reception closed , wireless wake-up mode	Transmitter must be mode 1
3 Sleep mode	1	1	Module into hibernation , and it can receive parameter setting command	

9.1 Mode switch

Users can M1, M0 high- low combinations to determine module operating mode. Recommend two GPIO to control the mode switch,

When running , you can switch to any mode.

If the module is free, it only needs 1ms to start work in accordance with the new model. If the module has not yet finished transmitting the serial data, then you need to wait until the launch is completed, the module can enter the new mode.

➤ **General mode(Mode 0)**

When M1 = 0, M0 = 0, the module operates in mode 0. In mode 0:

Transmit: Module receives user data from the serial port. When the module receives the first user data , the AUX output is low, when the module is to put all the data into the RF chip and started launch , the output is high. At this point , indicating that the last packet transmit wireless data has started , you can input up to 256 bytes of data.

Data packets sent through mode 0, it only can be received by the module which is mode1/0.

Receive: The module open the wireless receiver permanent feature, then it can receive the data packets from mode 0 and mode 1. The AUX will output low after the module receive data packets. After 5ms, the wireless data will be send out by the serial TXD. After all wireless data is output through the serial port , the AUX of module will output high.

➤ **Wake-up mode(Mode 1)**

When M1 = 0, M0 =1, the module operates in mode 1. In mode 1:

Transmit: Module startup data packet transmissions condition and the AUX function is equal to Mode 0. The only difference is: The modules will added an automatically wake-up code for each data packet , and the wake wake-up time will depends on the length of the code in the user parameter settings.

Receive: Equal to Mode 0.

➤ **Power-saving mode(Mode 2)**

When M1 = 1, M0 =0, the module operates in mode 2. In mode 2:

Transmit: Unable to transmit wireless data.

Receive: The modules which work in the Mode 2 require transmitter must operate in mode 1 . The wireless chip timing wakes up and listens the wake-up code , once the receipt of a valid wake-up code , the module will continue to be in receive mode , and waits for the entire valid data packet has been received . After the receiving is completed, the module will open the serial port and AUX will output low. After a delay of 5ms , the wireless data received will be send out by the serial port. After finish this process, the AUX will output high.

The following table shows that the different current under the different air velocity and the mean current response times(Nothing to do with the serial port baud rate): Module factory default is : 1KBPS / 250ms.

Rate\Delay	250ms	500ms	750ms	1000ms	1250ms	1500ms	1750ms	2000ms
1KBPS	1.16mA	0.580mA	0.391mA	0.295mA	0.237mA	0.198mA	0.170mA	0.150mA
10KBPS	179uA	92uA	63uA	48uA	39uA	34uA	30uA	27uA
20KBPS	121uA	63uA	43uA	34uA	27uA	24uA	21uA	19uA
25KBPS	121uA	63uA	43uA	34uA	27uA	24uA	21uA	19uA

➤ **Sleep mode(Mode 3)**

When M1 = 1, M0 =1, the module operates in mode 3. In mode 3:

Transmit: Unable to transmit wireless data.

Receive: Unable to receive wireless data.

Parameter setting: Sleep mode can be used to set the module parameters(Serial port 9600 and 8N1). Users can set a specific instruction format to change the module parameters . Specific details, please read the list of commands.

Notice: When entering from the sleep mode to another mode, the module will re- configuration parameters. The AUX will keep low in this process and it will output high after setting. Therefore, we recommend that users detect the rising edge of AUX.

10. Work parameter settings

When M1 = 1, M0 = 1, the module is in Mode 3 , in this mode , the user can set the operating parameters of the module via serial commands. *Note : No matter how much the baud rate is set by the user , this mode is fixed at : 9600,8N1.*

10.1 Work parameter settings

Below is a setting example. Note set inside the red box . Serial numbers are not necessarily COM3, please open the Device Manager to view.

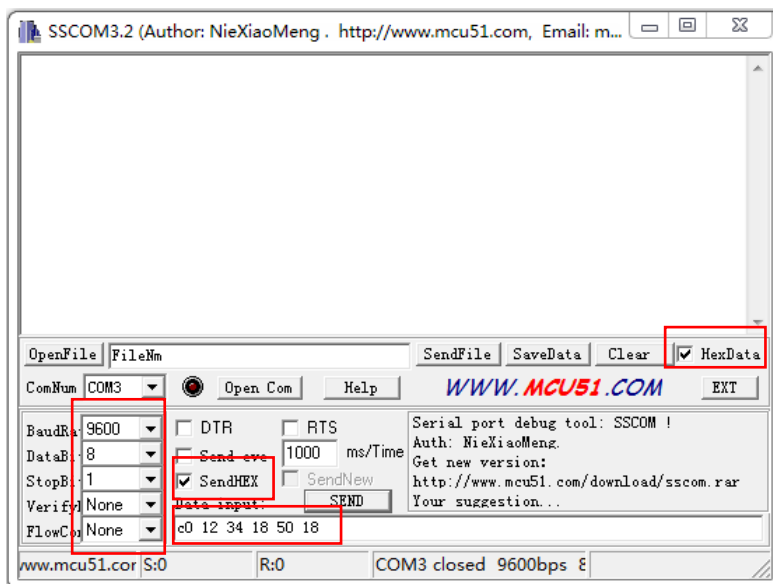

Figure 6

The default value (HEX format): C0H 12H 34H 18H 50H 18H parameters will be powered down to save. If C0 replaced by C2, the parameters are not saved for applications that require frequent changing parameters.

Num	Name	Description	Rmark
0	HEAD	Fixed 0xC0, indicates that this frame data for control commands	Must be 0xC0
1	ADDH	Modules address is high byte (Default 12H)	00H-0FFH
2	ADDL	Modules address is low byte (Default 34H)	00H-0FFH
3	SPED	<p>Rate parameters, including serial rate and air rate</p> <p>7, 6: Serial parity bit</p> <p>00: 8N1 (Default)</p> <p>01: 8O1</p> <p>10: 8E1</p> <p>11: 8N1 (Equivalent to 8N1)</p> <p>-----</p> <p>5, 4, 3 TTL serial rate (BPS)</p> <p>000: Baud rate of 1200</p> <p>001: Baud rate of 2400</p> <p>010: Baud rate of 4800</p> <p>011: Baud rate of 9600 (Default)</p> <p>100: Baud rate of 19200</p> <p>101: Baud rate of 38400</p>	<ul style="list-style-type: none"> Communicating parties serial mode can be different. Communication baud rate can be different sides. Baud rate and wireless transmission parameters is irrelevant and does not affect the radio's features .

		<p>110: Baud rate of 57600 111: Baud rate of 115200</p> <p>-----</p> <p>2, 1, 0 Wireless air rate (BPS)</p> <p>000: Air rate for 1K (Default) 001: Air rate for 2K 010: Air rate for 5K 011: Air rate for 10K 100: Air rate for 12K 101: Air rate for 15K 110: Air rate for 20K 111: Air rate for 25K</p>	<p>-----</p> <ul style="list-style-type: none"> ● Air rate is lower, the greater the distance, the stronger anti-interference performance, longer transmission time. ● Air communication between the two sides must have the same wireless transmission rate.
4	CHAN	Communication rate (425M + CHAN * 0.1M) (Default 50H:433M)	<ul style="list-style-type: none"> ● 00H-FFH, Corresponding 425 - 450.5Mhz
5	OPTION	<p>7, Fixed transmit enable bit (Category MODBUS)</p> <p>0: Transparent transmission mode 1: Former two-byte data frame as the destination address</p> <p>-----</p> <p>6 IO driven approach (Default 1)</p> <p>1: TXD、AUX push-pull output, RXD pull- input 0: TXD、AUX open output, RXD open input</p> <p>-----</p> <p>5, 4, 3 Receiving a response time (The current value is under the control mode, Transparent transmission mode current is the same, Air rate below the current value is 10K :</p> <p>000: 250ms (Default) 001: 500ms 010: 750ms 011: 1000ms 100: 1250ms 101: 1500ms 110: 1750ms 111: 2000ms</p> <p>-----</p> <p>2, 1, 0 Transmit power (About values)</p> <p>000: 20dBm (Default) Peak emission current 85mA 001: 17dBm Peak emission current 67mA 010: 14dBm Peak emission current 41mA 011: 11dBm Peak emission current 33mA 100: 8dBm Peak emission current 24mA 101: 5dBm Peak emission current 24mA 110: 2.5dBm Peak emission current 24mA 111: 0dBm Peak emission current 24mA</p>	<ul style="list-style-type: none"> ● When equal to 1, the first two bytes of data per user frame as the level of address. When transmitting data, the module to change their address, after launch, the addressed recovery. ● This bit is used to enable the module internal pull up resistor. Open-drain mode level adaptable, but in some cases, you may need an external pull-up resistor. ● Transceiver modules are working in mode 0, the delay time is invalid, can any value. ● Transmitter operate in mode 1, and transmit wake-up code of the corresponding time. ● Receiver operate in mode 2, data can only come from a transmitter which is in mode 1, the setting here is to receive the delay time. ● Delay transmitter settings can't be less than the recipient, or it may lose data. when the two-way communication, the two sides can be set to the same. ● The greater the delay, the lower the average reception current. ● Emission current peak value refers to the current moment of data transmission. ● External power supply must provide more than 200mA output current capability. And to ensure that the power supply ripple is less than 100mV ● Not recommended to use less power to send, its power efficiency is not high.

10.2 Work parameter reading

In sleep mode (M1 = 1, M0 = 1), User sends "C1H C1H C1H" to the serial port module, module will return the user's parameters which has been set. Such as: C0H 12H 34H 18H 50H 18H.

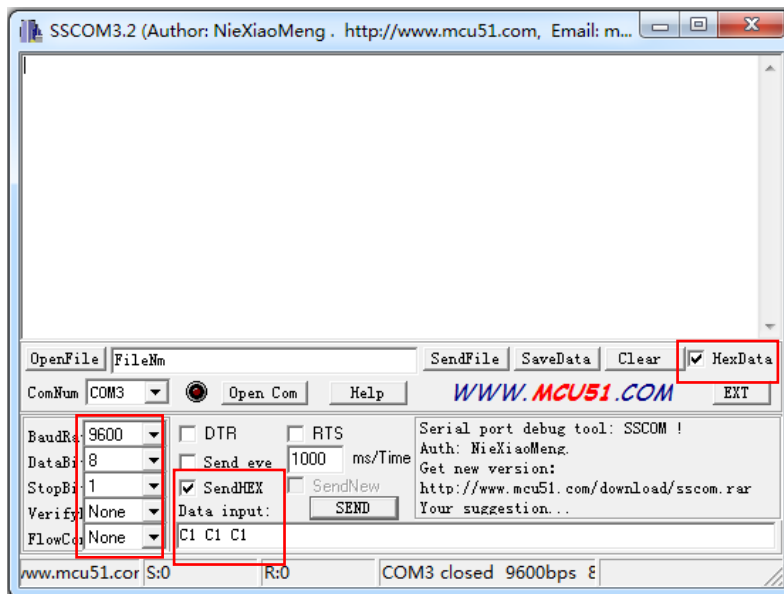

Figure 7

10.3 Specified transmission mode

When the bit 7 is 1, the first three bytes of user's data will be used as the destination address and transmission channel, rather than valid data. For example: Address of the module 1 is 0001, channel 50, the address is 0002 module 2, channel 51. In transparent transmission mode, the two modules can't communicate. So the module provides a solution: Specify transmission mode.

When OPTION.7 = 1 (Please refer to the operating parameters set) can achieve interoperable communication of two modules. Specific measures are: the OPTION.7 write 1, in front of the transmitted data, we should determine the address and channel. *For example: Module 2 need to transmit data "AA BB CC" to module 1, the communication format : 00 01 50 AA BB CC. Similarly, if module 1 need to transmit data "AA BB CC" to module 2, the communication format : 00 02 51 AA BB CC. Then the module can receive 2 AA BB CC.*

Application:

- The module can communicate with different channels and addresses.
- Due to the different channels, it can achieve a single point to wake up. The module which doesn't need to wake up will not receive data and not affect the power consumption.
- When this mode is enabled (OPTION.7 = 1), the single significant byte packet length can't be greater than 55 bytes. After the data is sent to the module, wait AUX is high, you can initiate a data next.

10.4 Broadcast and data monitor

The module address is set to 0xFFFF, you can listen to any data transmission on the same channel, the data transmitted on the same channel can be received at any address. Which plays the role of radio and listens.

10.5 Read the version number

In Sleep Mode (M1 = 1, M0 = 1), user can send "C5H, C5H, C5H" to serial port of the module, the module will return the current voltage value. The return format: C5H VH VL, VH and VL representative the voltage data. Such as: C5H 0CH 1CH, 0C1C converted to decimal for 3100, it indicates that the current voltage of 3.1V.

11. Quick test and Set

11.1 Supporting USBTTL (E15-USB-T2)

1. Disconnect the jumper cap(In Sleep mode can be configured parameters)
2. Open the parameter configuration software (we offer).

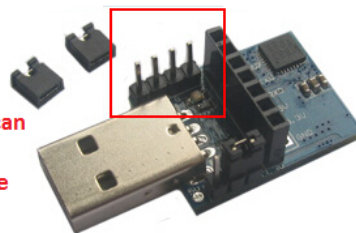

If the read module fails, please choose another COM port

First click 【打开串口】
The next click 【读取串口参数】

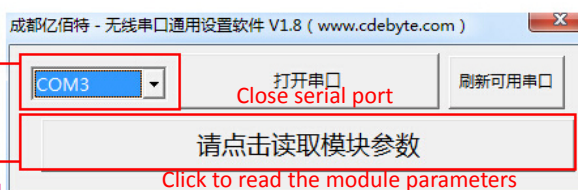

Figure 8

1. Plug two jumpers hat(Enter the transparent transmission mode)
2. Open the serial debugging assistant(We can provide it)

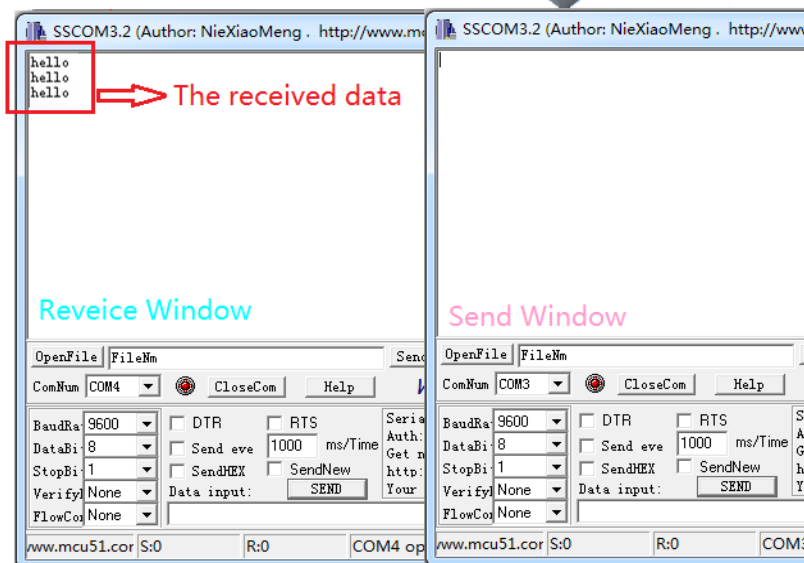
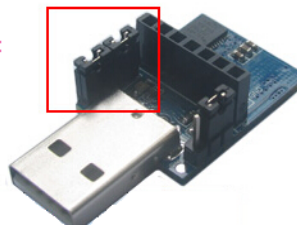
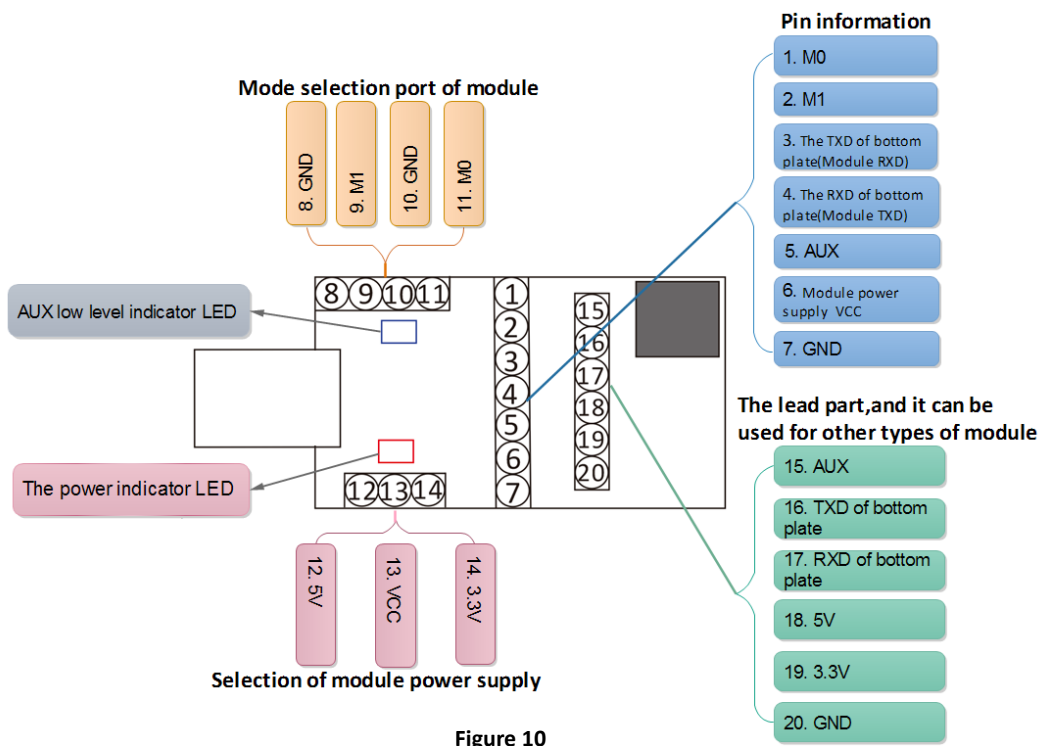

Figure 9

- Below is our proprietary RF-USB-T2 adapter plate. User can connect the RF-TTL-100 directly to use.
- RF-TTL-100 module can't use the 5V power supply, so you should choose a 3.3V power supply. Please use a jumper cap to connect 13 and 14 feet.
- 15 to 19 pin leads the power foot and other pins.



11.2 Driver installation

If you are the first time to use the CP2102 interface converter module, you need to install a new driver: **CP2102 USB to UART Bridge Controller**. You can get it from: www.inhaos.com.

The following are installation steps:

- 1) Get the installation package and extract.

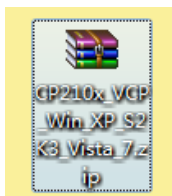

Figure 11

- 2) Double click .exe program file, enter the Setup program.

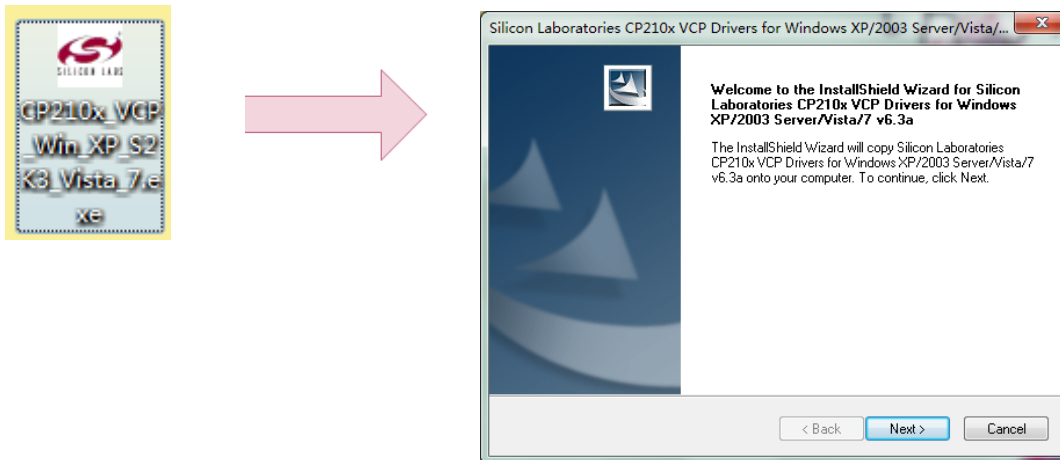

Figure 11

- 3) After entering the interface, follow the prompts to install the program.

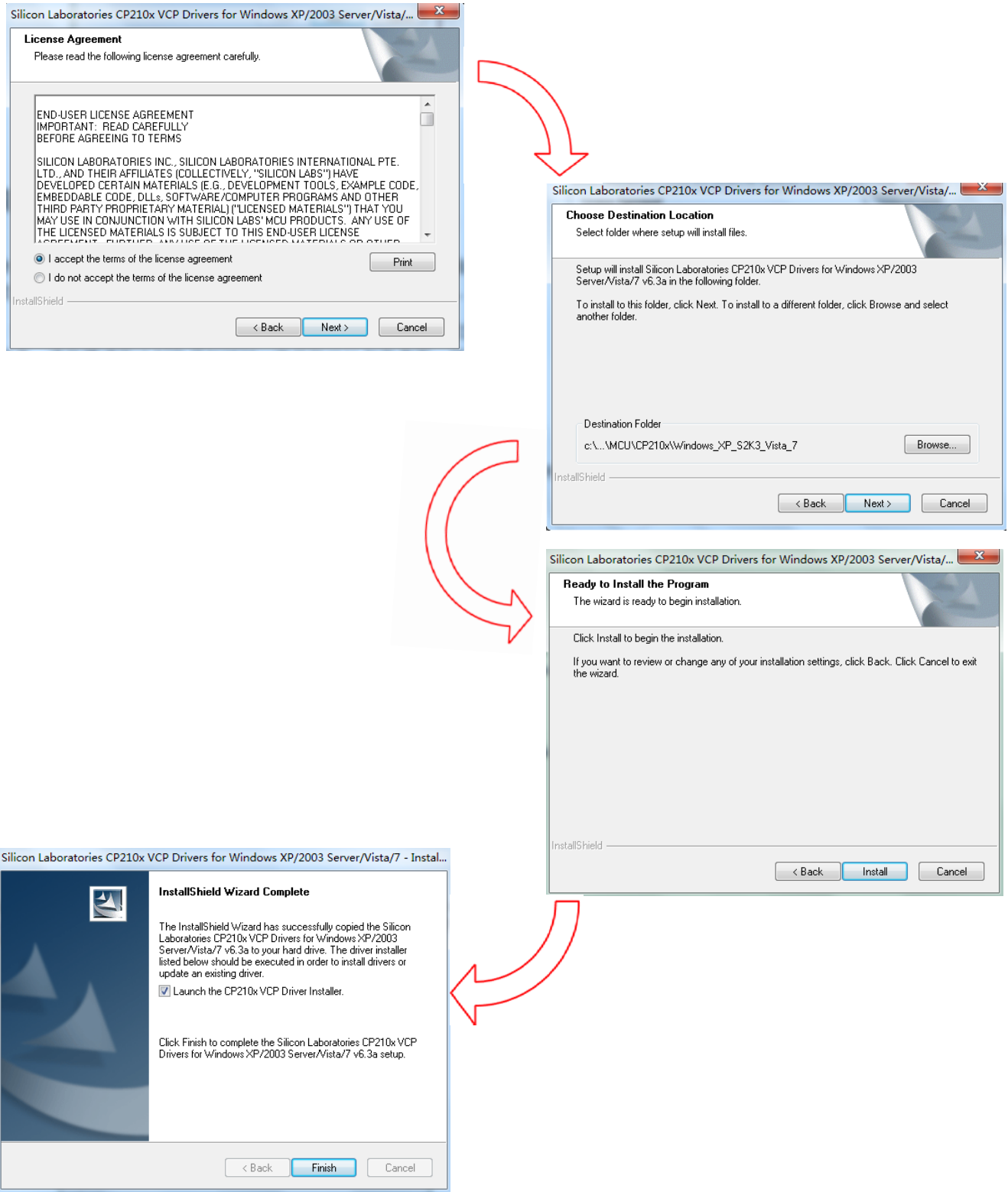

Figure 12

4) After clicking **Finish** will enter the interface as shown. Now you need to click **Install**.

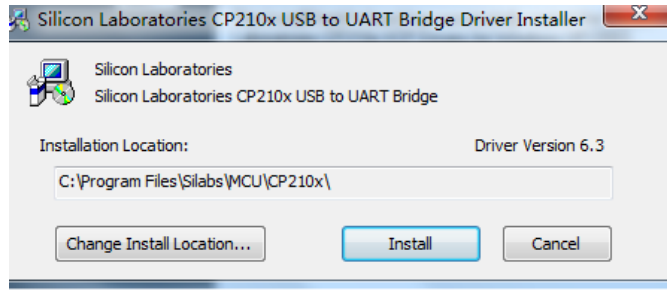

Figure 13

11.3 Module communication test

After the driver installation is complete, you can put two RF-USB-T2 adapter plate into the computer USB port and plug the module, configured the work mode.

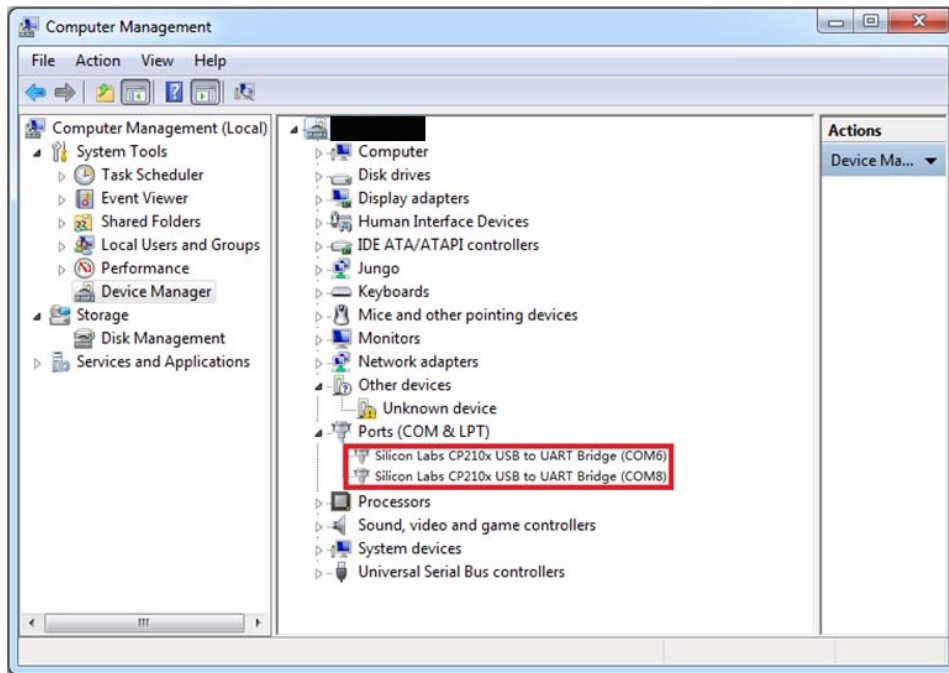

Figure 14

At this point, you should be M0 and M1 are grounded. The method of connection is shown in Figure 9. And then the module is operating in Mode 0.

Please turn on two serial assistant software, and configure the serial port 9600, 8N1. The one you can used to send a string: 123456789, the other one will receive the string. Thus proved that the module is working.

For mode 1, 2, 3, using the single-chip control will be more flexible.

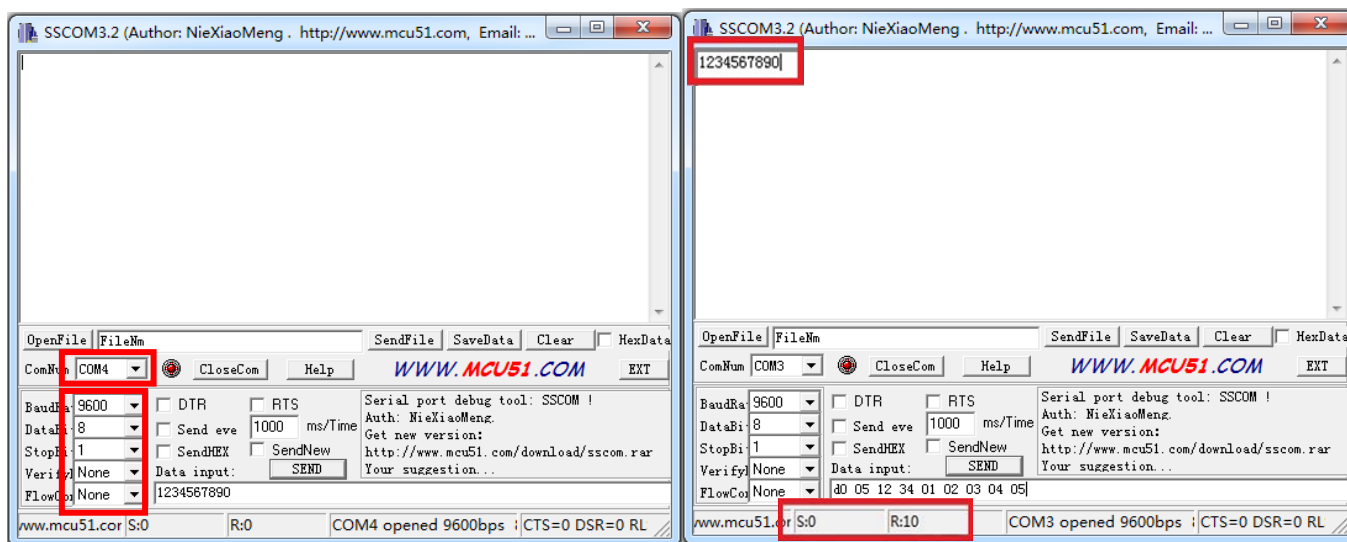

Figure 15

11.4 Parameter setting selection

Make modules M1, M0 vacant, the module will go into sleep mode which is namely the setting mode, at this time.

11.5 Supporting the use of PC setup software

- Before you use the PC software, please keep the USB board connection to your computer and keep M0,M1 vacant. So the module will works in sleep mode.
- Ensure that the driver has been installed correctly , and select the appropriate serial number.

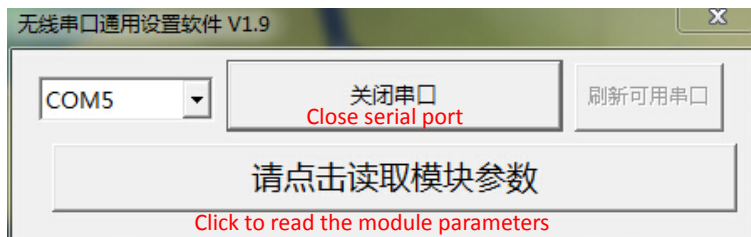

Figure 16

- The software can automatically reads the module type and other parameters. Now you can modify and write.

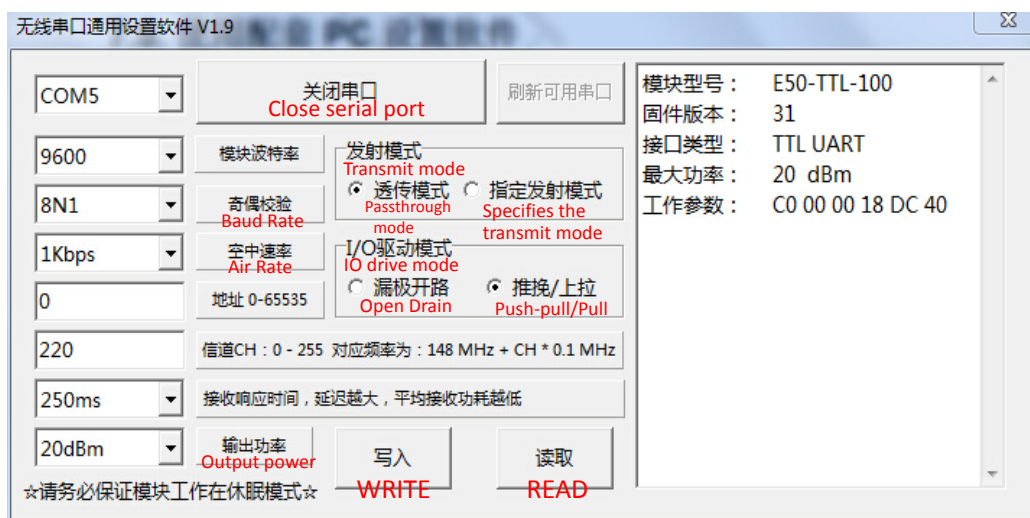

Figure 17

12. Module operation flowchart

We recommend that users use the following procedure MCU operating wireless module.

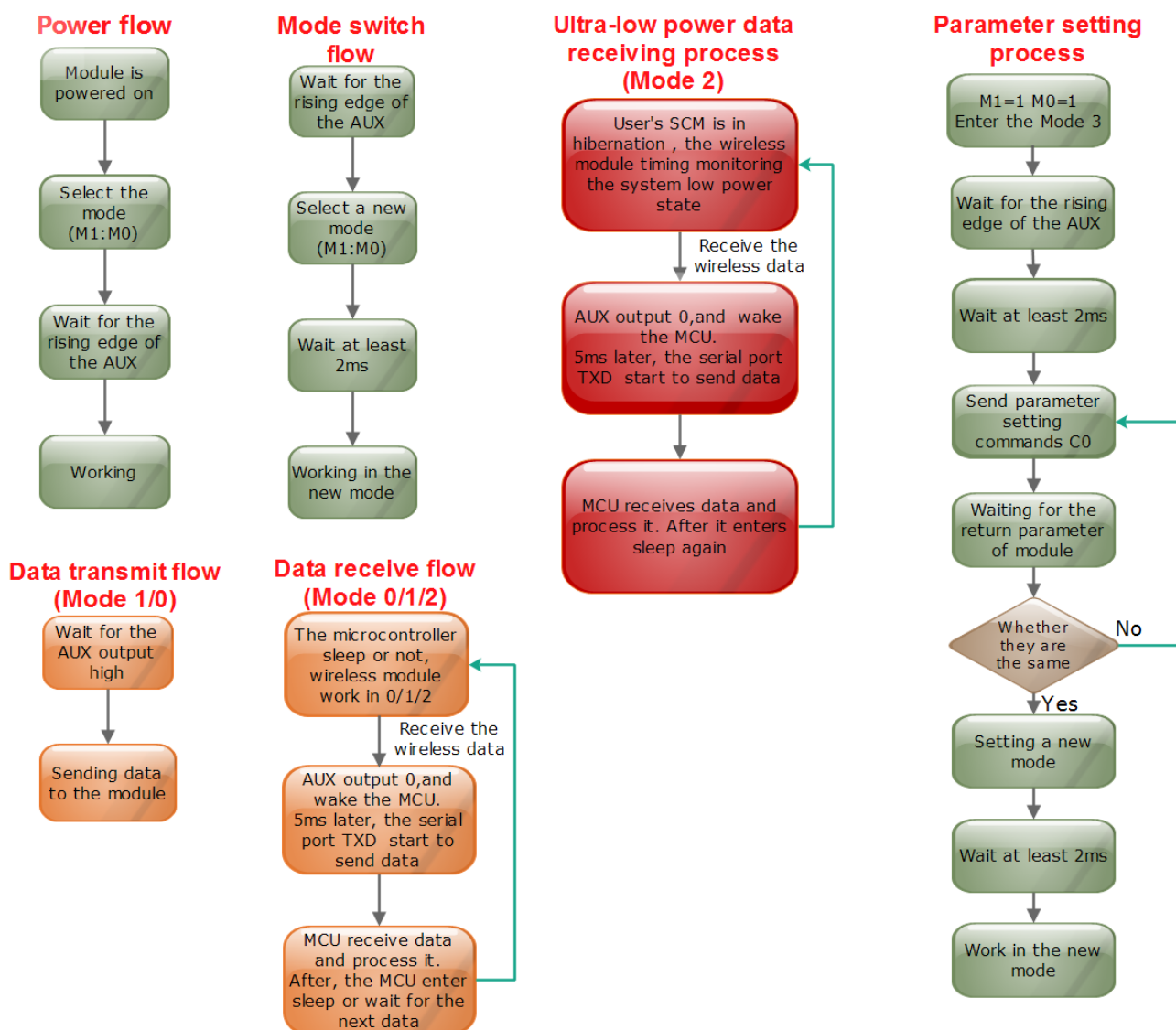

Figure 18

13. Wireless Networking Applications

13.1 Point to point transmission

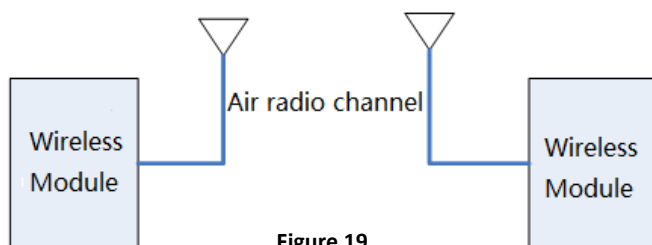

Figure 19

13.2 Star Network Architecture

In a star network architecture, users can assign an address to each slave. The address will be included in the host transmitted. And the slave will determine whether the address matches with itself. If it matches, the slave will perform the appropriate action; otherwise, the slave discard the data.

Notice: In this mode, the host must initiate communication, and the slave response. Must ensure that the communication radius within

the same time , there is only one host to transmit data. If not, it will easily lead a communication confusion.

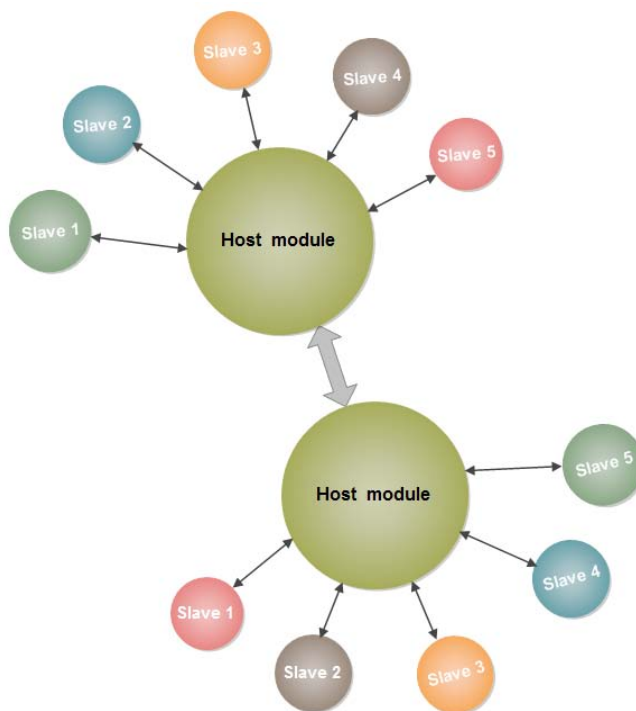

Figure 20

13.3 Other network transmission

E30 module adopts transparent transmission , users can add their own data in the software address , and use single-chip filtering, forwarding and other functions , you can achieve a very good and simple network model.

You can use a small low cost microcontroller, the only requirement about it is to be able to the use serial communication. **This can help users to significantly reduce costs and development time.**

14. Common Problems

14.1 Connect TTL serial port, the module output some garbled

- 1) May be not compatible with TTL level , you can use our USB-TTL module to be tested.
- 2) For the invisible characters , the PC serial port assistant may give a hand . Please use the HEX display.

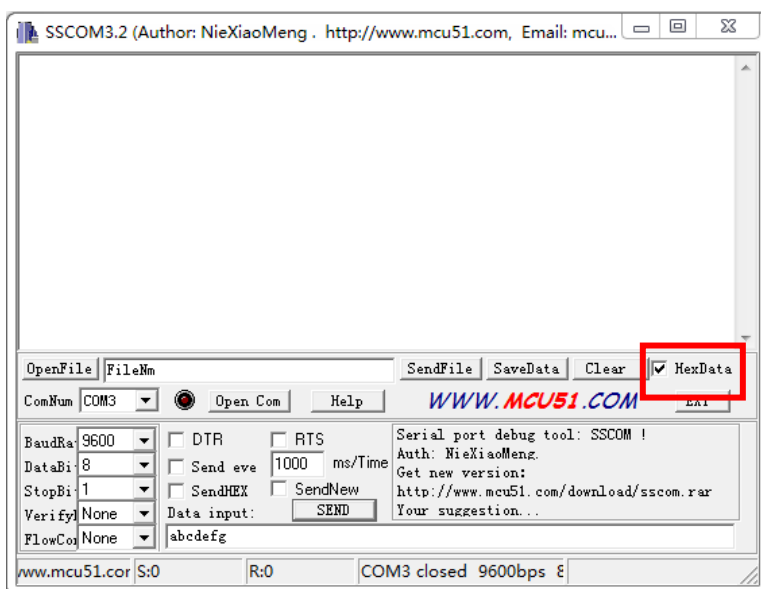

Figure 21

14.2 Communication on both sides of the serial port baud rate may not be the same but the wireless air rate must be the same

14.3 USB-TTL is working properly, but the microcontroller is not normal

- 1) Please check the MCU RXD and TXD which is connect with the module.
- 2) Add a 4.7K - 10K pull-up resistor between the TXD and RXD of the module.
- 3) Power supply or other causes.

14.4 Causes and methods of data loss

Causes:

- 1) Range of communications is already in critical state.
- 2) The air rate is too high.
- 3) Transfer the amount of data is too large, since the processing capability of the module is not enough or air transmission rate is too low. Resulting in overflow loss.
- 4) Response time of receiver set greater than the transmit side .

Methods:

- 1) Reduce the air speed.
- 2) Reduce the single communication data amount.
- 3) Choose a high-power module.

14.5 Unable to carry on the communicate of 8E1,801

This is generally due to the use of the serial assistant software, or USB-TTL module. The more serial assistant software or virtual serial chip is not well support for this function. Please use the microcontroller right write the 8E1/801 test program.

14.6 In the normal communication area, the packet loss is high

Possible reasons are as follows:

- 1) The wireless response time settings don't match in the parameter setup. So it may cause that the receiver cannot receive data.
- 2) There is a radio interference. It is recommended to switch the channel and address.

14.7 The wireless transmission is delay significantly

It is a normal phenomenon that the wireless transmission delay slight increase or decrease. If the delay is too obvious , it is likely that the current channel blockage , and the module is trying to find the best time to launch . If there are other modules in the same area of the same frequency , can also cause such a blockage .

14.8 Some module can transmit data, but cannot receive

- 1) Response time of the module is set larger than the other. This results in the data can be transmitted to each other, but can not receive any data returned.
- 2) Whether the current module into sleep mode.
- 3) The air speed of communicating partise must be identical.
- 4) External UART level should be as close to the module voltage.

14.8 Both sides completely unable to communicate

- 1) The radio rates / channel or address of both communication module can be inconsistent.
- 2) The receiver is in sleep mode.

14.9 The elevation of wireless rate will reduce the distance.

This is a normal phenomenon, and it is the common physical characteristics of all wireless communication applications. Communication rate increase will result reduced receiver sensitivity in greatly, and the anti-jamming capability will be weakened. Notice: Serial port baud rate and wireless features are irrelevant.

14.10 Abnormal power

Generally it is due to the level of matching problems. Such as: The module with a 3.3V power supply, the serial port level is 3.3V. The RXD/TXD and AUX

15. Notice:

1. Avoid body touch the electronic components.
2. Please ensure that the power supply has a smaller ripple , and must avoid frequent significant jitter.
3. Antenna mounting structure has a greater impact on module performance , please ensure the antenna exposed.
4. Avoid harmonic interference from other wireless devices bands.
5. Please make the RF module stay away from the crystal.

16. Information link

17. Contact us

1111 Oakmont Drive #C, San Jose, CA 95117

Contact: John Huang

Tel No: +1-408-981-6615

E-mail: support@inhaos.com